



Network Video Recorders

Quick Guide

Version: V1.01

BOM: 3101C0FC

Thank you for purchasing our product. Contact your local dealer if you have any questions or feedback. No part of this manual may be copied, reproduced, translated, or distributed in any form or by any means without prior consent in writing from our company. Contents of this manual are subject to change without prior notice. No statement, information, or recommendation in this manual shall constitute formal guarantee of any kind, expressed or implied.

Safety Information

Read through the instructions carefully before starting installation and operation.

- Installation and maintenance must be performed by qualified personnel.
- This device is a class A product and may cause radio interference. Take measures if necessary.
- Disconnect power before installation and cable connection. Wear antistatic gloves during installation. Use the manufacturer recommended battery. Improper use or replacement of the battery may cause risk of explosion. Dispose of the used battery according to local regulations or the battery manufacturer's instructions. Never dispose of the battery in fire.
- The device is intended for indoor use only. Ensure a proper operating environment, including temperature, humidity, ventilation, power supply, and lightning protection. The device must always be properly grounded. Keep the device from dust, excessive vibration, liquid of any kind, and strong electromagnetic radiation. A sudden power failure may cause device damage or loss of data.
- Take necessary measures to ensure data security and protect from network attack and hacking (when connected to Internet).

Regulatory Compliance

FCC Part 15

This equipment has been tested and found to comply with the limits for digital device, pursuant to part 15 of the FCC Rules. These limits are designed to provide reasonable protection against harmful interference when the equipment is operated in a commercial environment. This equipment generates, uses, and can radiate radio frequency energy and, if not installed and used in accordance with the

instruction manual, may cause harmful interference to radio communications. Operation of this equipment in a residential area is likely to cause harmful interference in which case the user will be required to correct the interference at his own expense.

This product complies with Part 15 of the FCC Rules. Operation is subject to the following two conditions:

- This device may not cause harmful interference.
- This device must accept any interference received, including interference that may cause undesired operation.

LVD/EMC Directive



This product complies with the European Low Voltage Directive 2014/35/EU and EMC Directive 2014/30/EU.

WEEE Directive–2012/19/EU



The product this manual refers to is covered by the Waste Electrical & Electronic Equipment (WEEE) Directive and must be disposed of in a responsible manner.

▶ Default IP, Username and Password

- Default IP address: **192.168.1.30** or **192.168.0.30** (vary with firmware version)
- Default admin username: **admin**
- Default admin password: **123456** (only for first login and should be changed to a strong one with at least 8 characters including upper and lower case letters, digits and symbols to enhance account security.)

Disk Installation

Choose an option. Use a 1# or 2# screwdriver as needed. All photos are only for illustration.

Option 1 (for 1 or 2 disks)

1. Remove the cover, connect data and power cables to disk(s), and then secure disk(s) with screws.
2. Connect data and power cables to the motherboard and then install the cover.

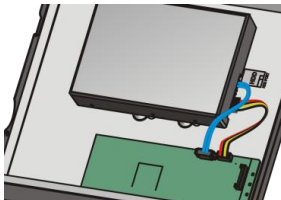
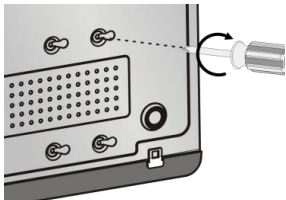

Option 2 (for more than 2 disks)

You will open the cover and install hard disks on mounting plate(s).

1. Remove the cover and then secure disks to mounting plate(s) with screws.
2. Connect data and power cables to disks. Secure mounting plate(s) to the device, and then install the cover.

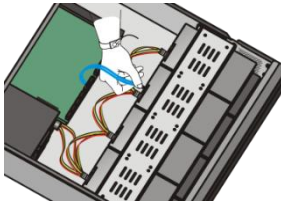
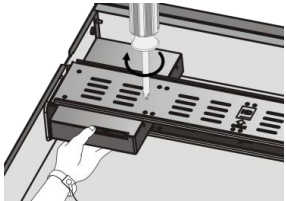

Option 3 (for more than 2 disks)

You will open the front panel and install hard disks on mounting brackets.

1. Secure the disk to a pair of mounting brackets (L means left and R means right).
2. Press the latches on both sides (1) and then detach the front panel (2).

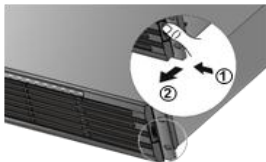

3. Align the disk at the slot and then insert the disk gently.
4. Push the disk slowly until it clicks. Repeat the steps to install all disks and then close the front panel.

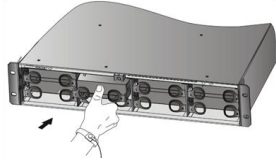
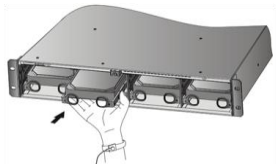

▶ Ports, Interfaces and LEDs

The ports, interfaces, connectors, power on/off switch and LED indicators may vary with device model. See the following two examples.

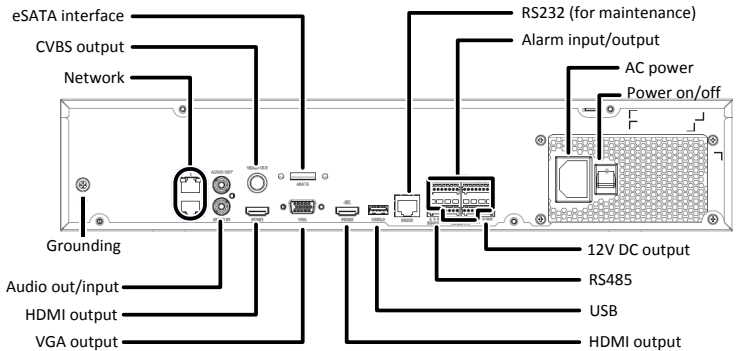
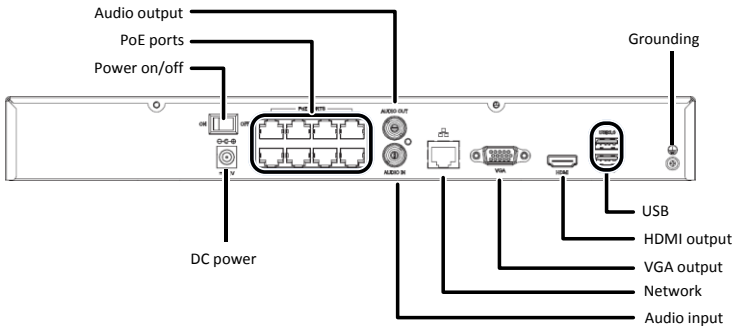

LED	Description
PWR(Power)	Steady on: Connected to power.
RUN(Operation)	<ul style="list-style-type: none"> Steady on: Normal. Blinks: Starting up.
NET(Network)	Steady on: Connected to network.
GUARD(Arming)	Steady on: Arming is enabled.
IR	<ul style="list-style-type: none"> Steady on: Activated for remote control. Blinks: Authenticating device code.
ALM(Alarm)	Steady on: Device alarm occurred.
CLOUD	Steady on: Connected to cloud.
HD(Hard disk)	<p>One HD LED only:</p> <ul style="list-style-type: none"> Steady on: No disk; or disk is abnormal. Blinks: Reading or writing data. <p>One HD LED for each disk:</p> <ul style="list-style-type: none"> Steady green: Normal. Blinks green: Reading or writing data. Steady red: Abnormal. Blinks red: Rebuilding array.

Startup

Verify installation and cable connection are correct. Connect to power and then turn on the power on/off switch (if applicable). Follow the wizard to complete the basic setup after the NVR starts up.

Live View

Click **Menu > Camera > Camera**. The discovered cameras are listed. Click  to add a camera. To search a network segment, click **Search**. If a camera is added but live video is not available, check network connection and make sure the correct camera username and password are set in the system. Modify if necessary.

Playback

Right-click a preview window and then choose **Playback** to view video recorded on the current day. A 7×24 recording schedule is enabled at delivery and can be edited under **Menu > Storage > Recording**.

Access Using a Web Browser

Access the NVR using a Web browser (e.g., Internet Explorer) from a connected computer.

1. Enter the NVR's IP address in the address bar and then press **Enter**. Install the plugin as prompted. Close all Web browsers when the installation starts.
2. Open the Web browser and log in with the correct username and password.

Shutdown

Use the **Shutdown** menu instead of by disconnecting power or turning off the power on/off switch. A sudden power failure may cause device damage and loss of data.