

Serial BUS RS485 sviluppo e indirizzamento



Tecn**alarm**

Hi-Tech Security Systems

design by *pininfarina*

Rosso Nero (2x1)
Alimentazione

Azzurro Nero Twistato
(2x0,50) segnali A e B

Giallo (1x0,50) segnale S
per Consolle e Tecnocell

Cavo per Serial BUS RS485
Codice F11200000228



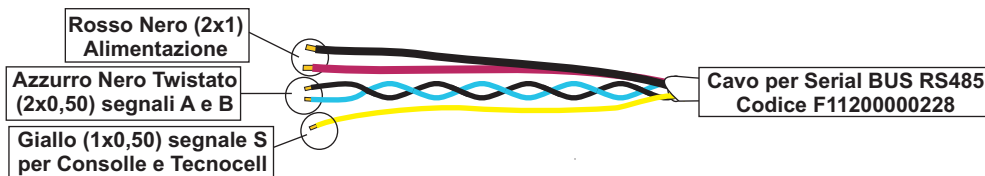
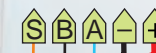
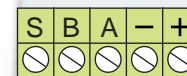
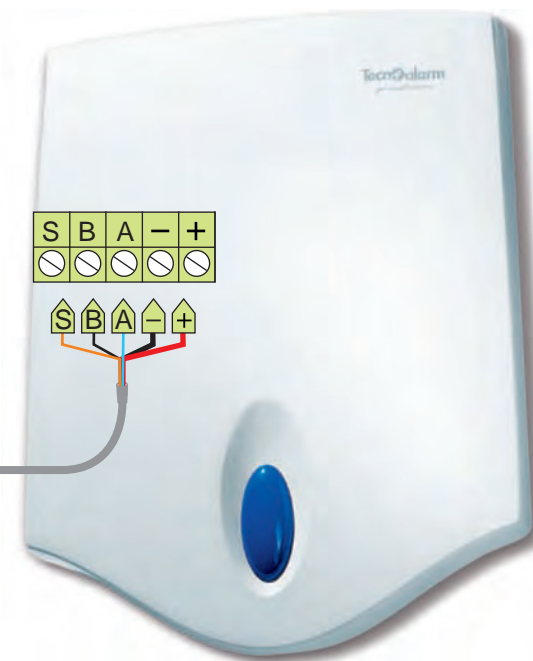
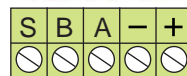

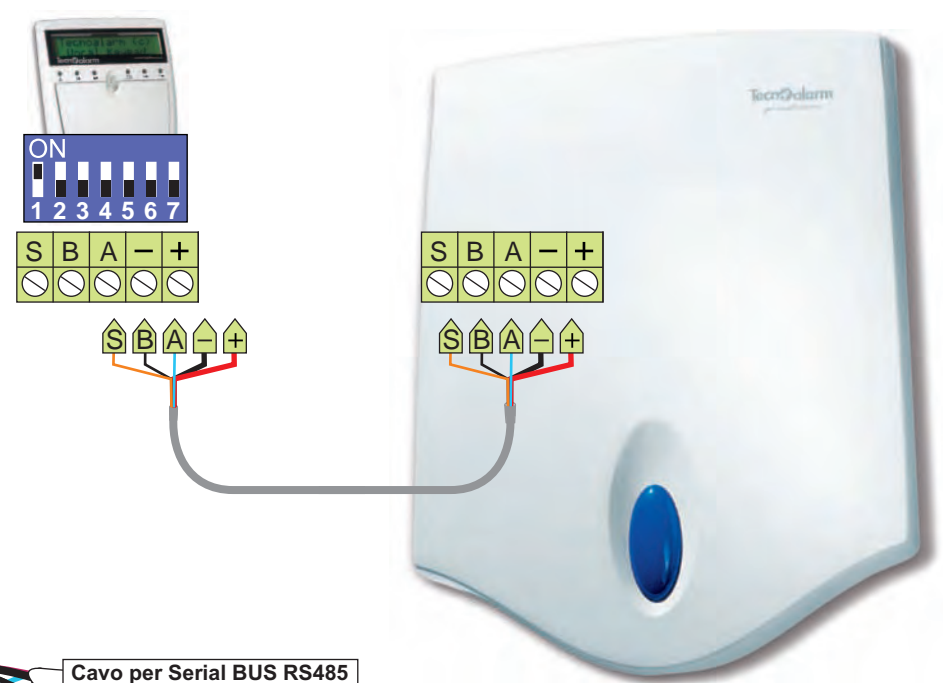

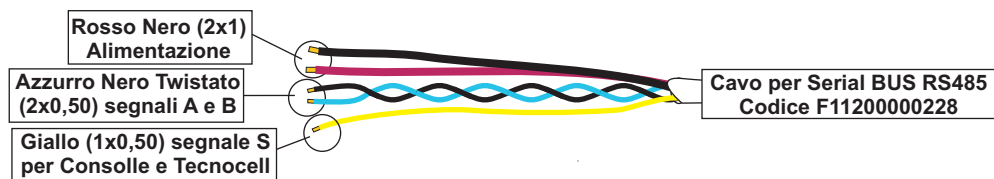
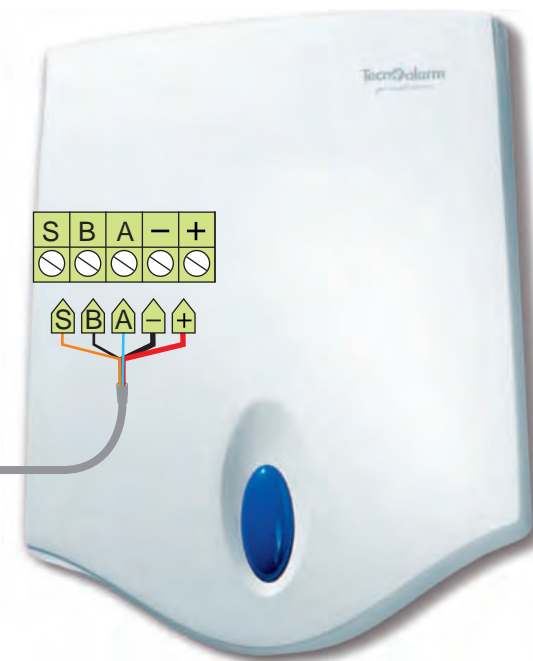

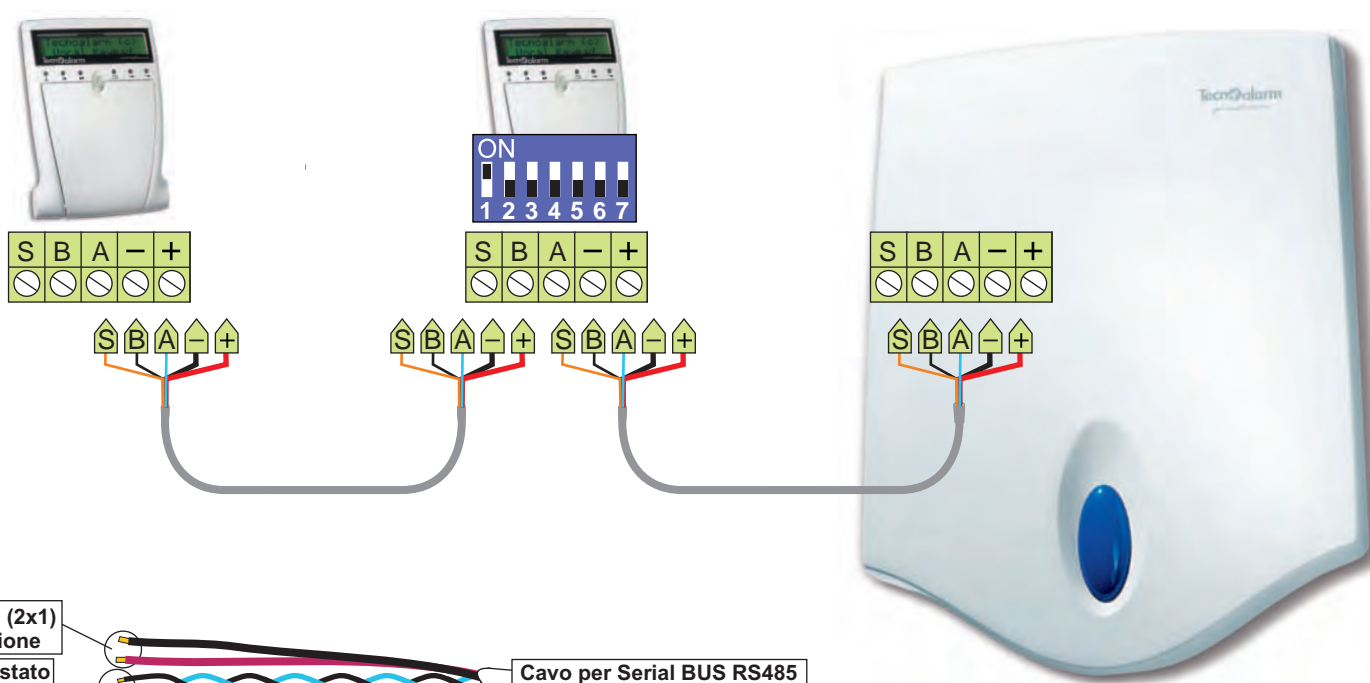

Rosso Nero (2x1)
 Alimentazione

Azzurro Nero Twistato
 (2x0,50) segnali A e B

Giallo (1x0,50) segnale S
 per Consolle e Tecnocell

Cavo per Serial BUS RS485
 Codice F11200000228

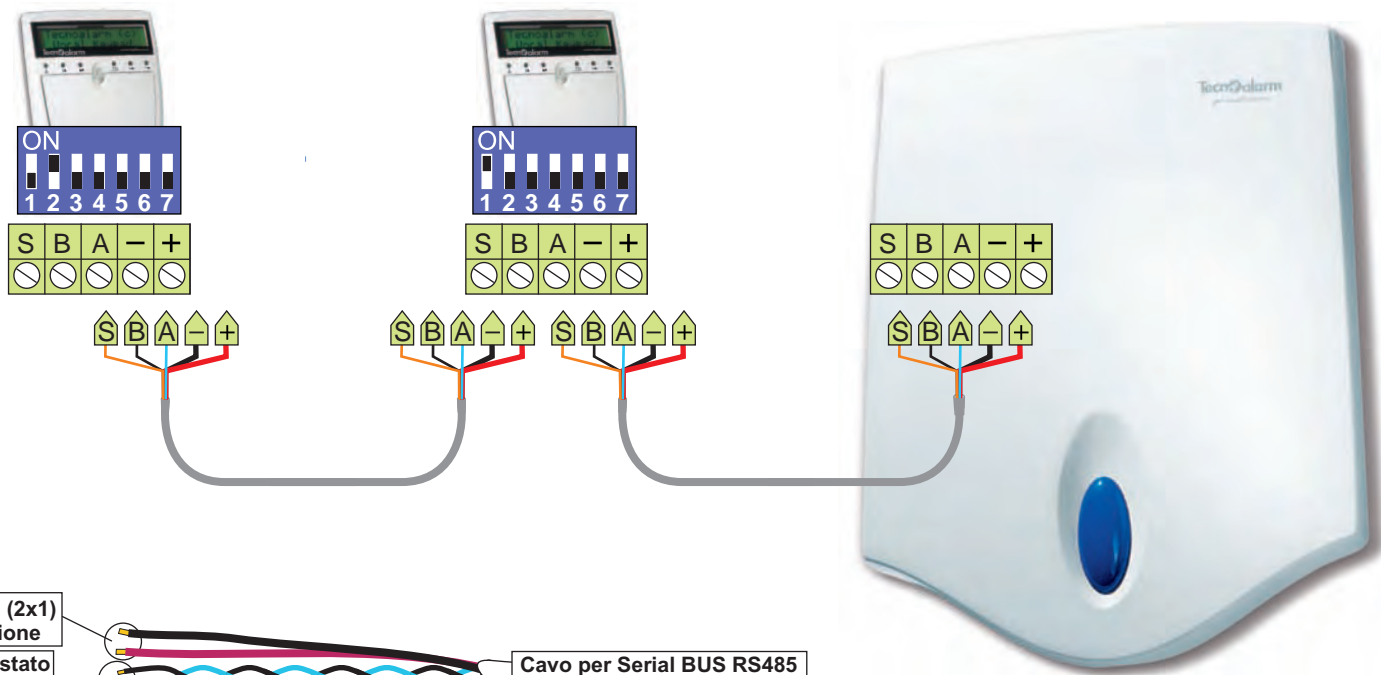

Rosso Nero (2x1)
 Alimentazione

Azzurro Nero Twistato
 (2x0,50) segnali A e B

Giallo (1x0,50) segnale S
 per Consolle e Tecnocell

Cavo per Serial BUS RS485
 Codice F11200000228

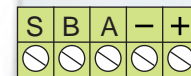
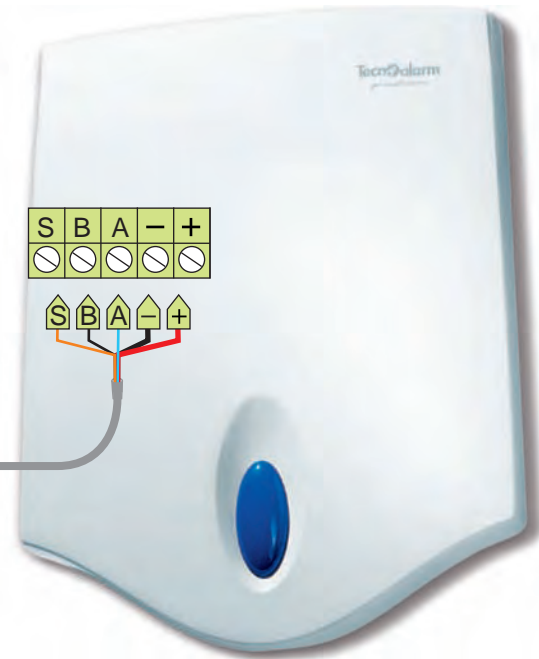
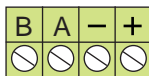

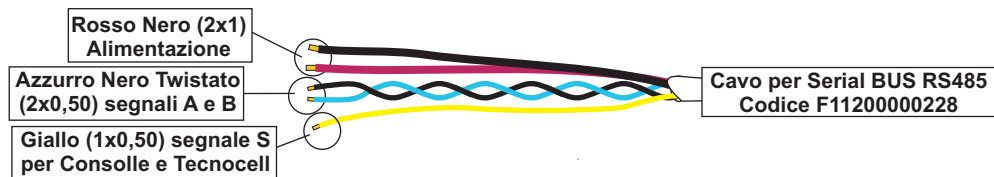
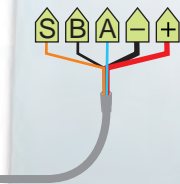
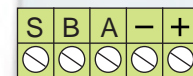
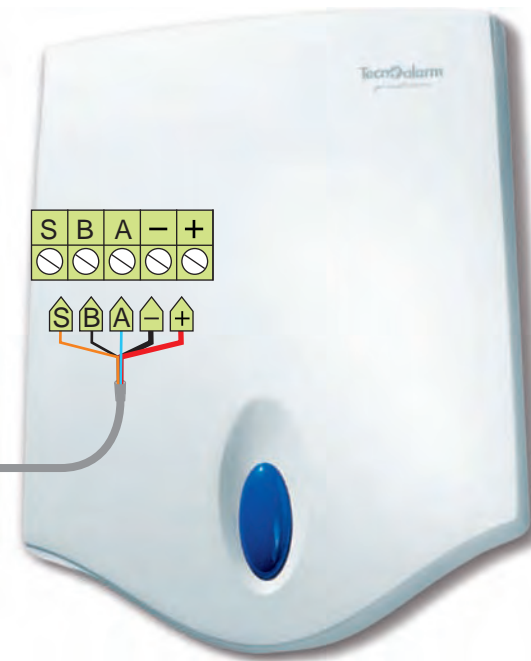
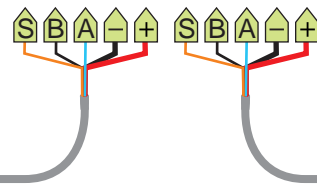
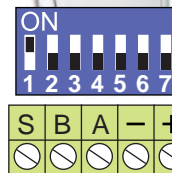
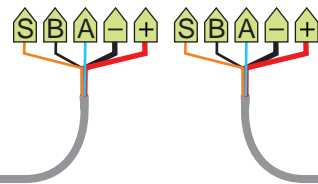
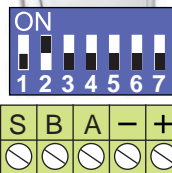
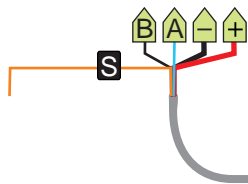

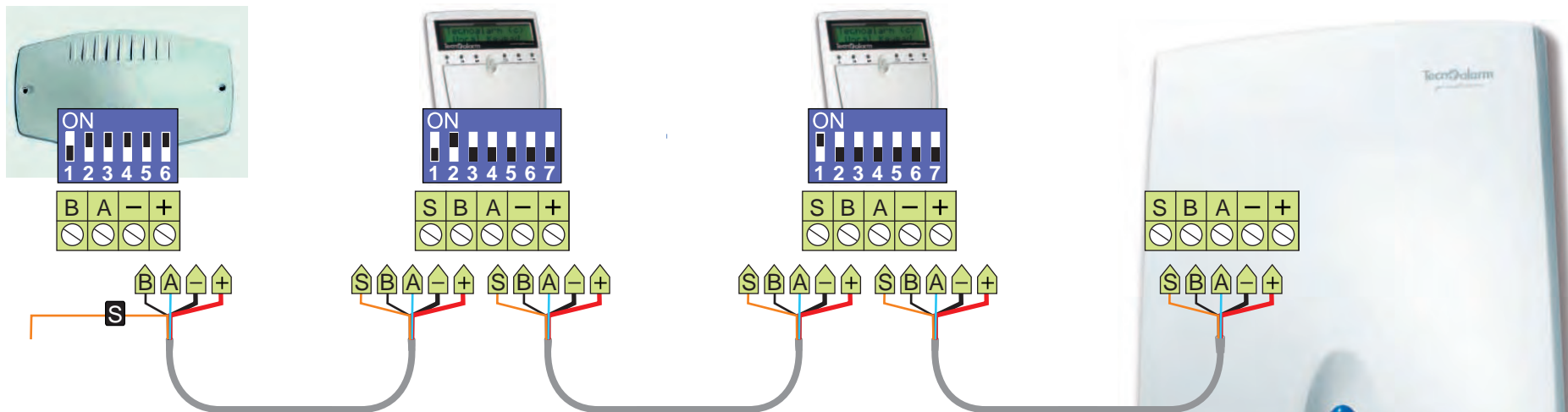

- Rosso Nero (2x1)
Alimentazione
 - Azzurro Nero Twistato
(2x0,50) segnali A e B
 - Giallo (1x0,50) segnale S
per Consolle e Tecnocell
- Cavo per Serial BUS RS485
Codice F11200000228

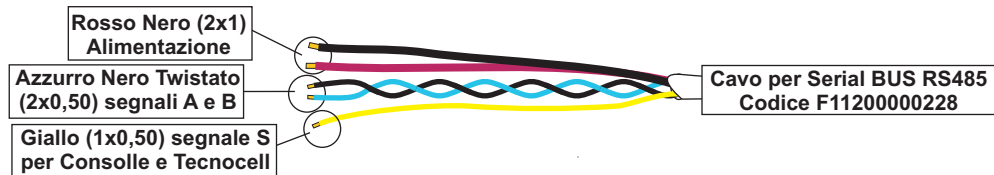
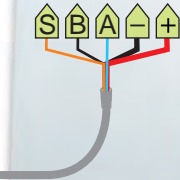
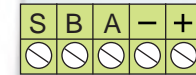
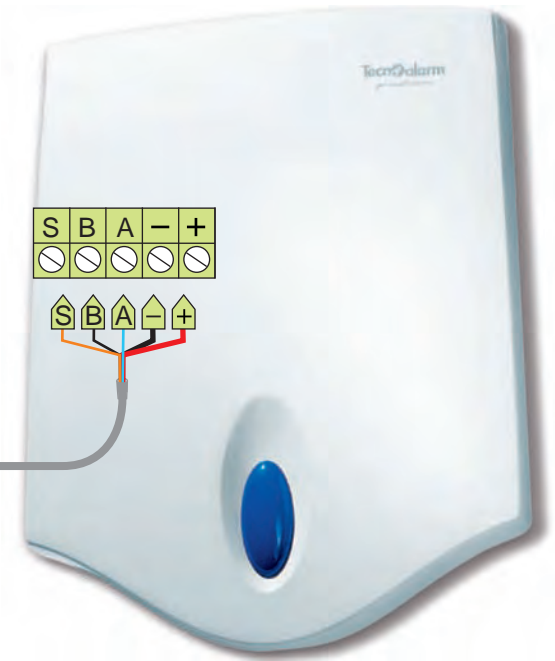
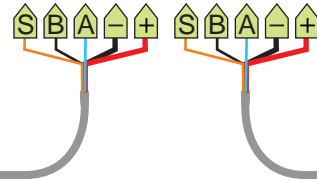
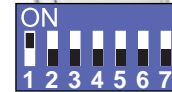
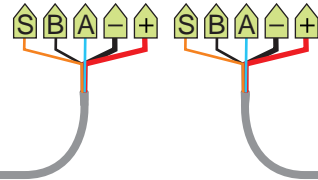
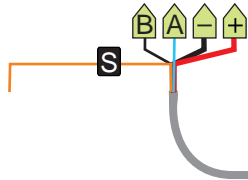
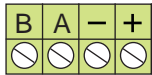
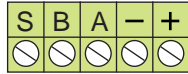

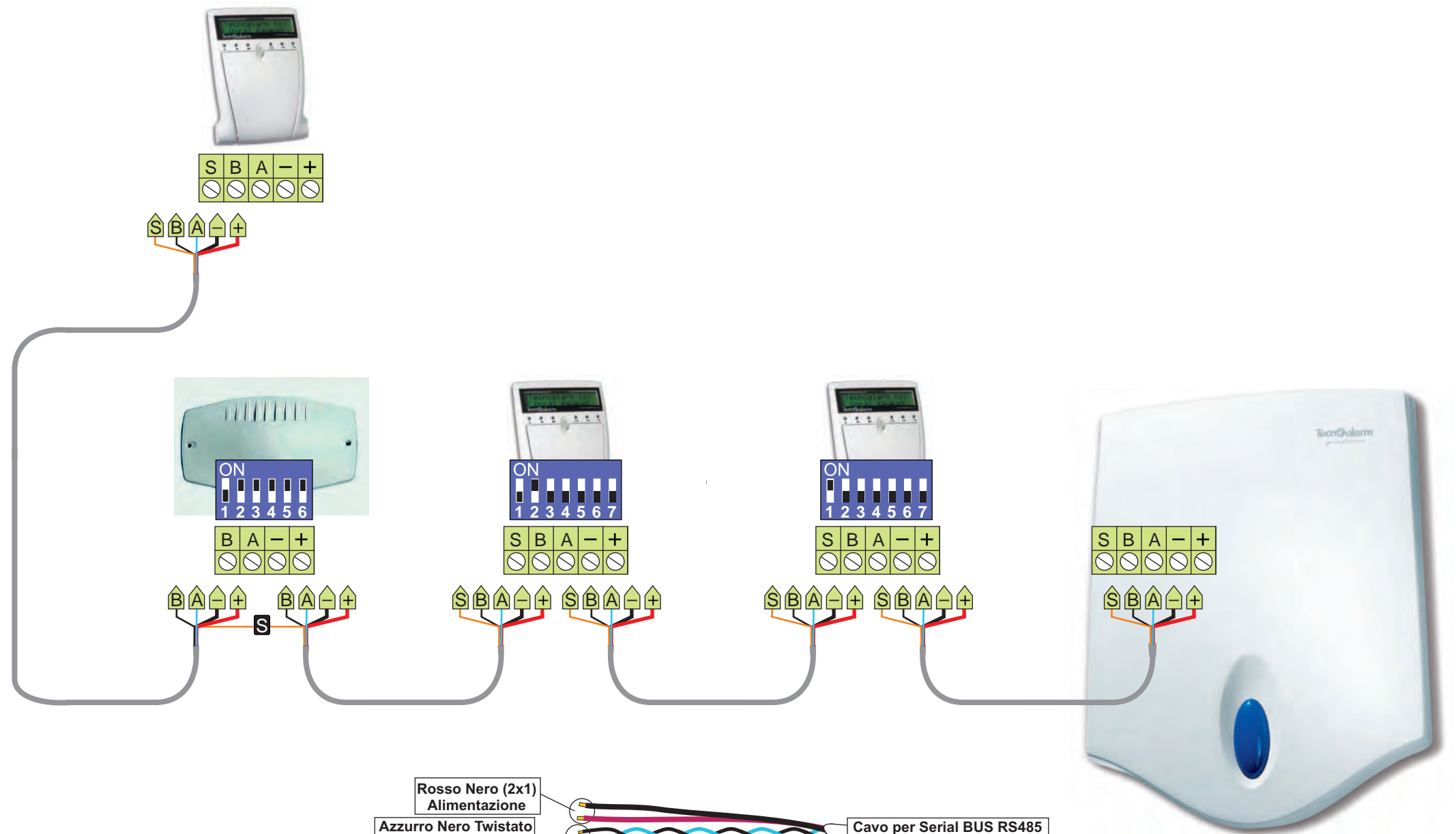

- Rosso Nero (2x1)
Alimentazione
 - Azzurro Nero Twistato
(2x0,50) segnali A e B
 - Giallo (1x0,50) segnale S
per Consolle e Tecnocell
- Cavo per Serial BUS RS485
Codice F1120000228

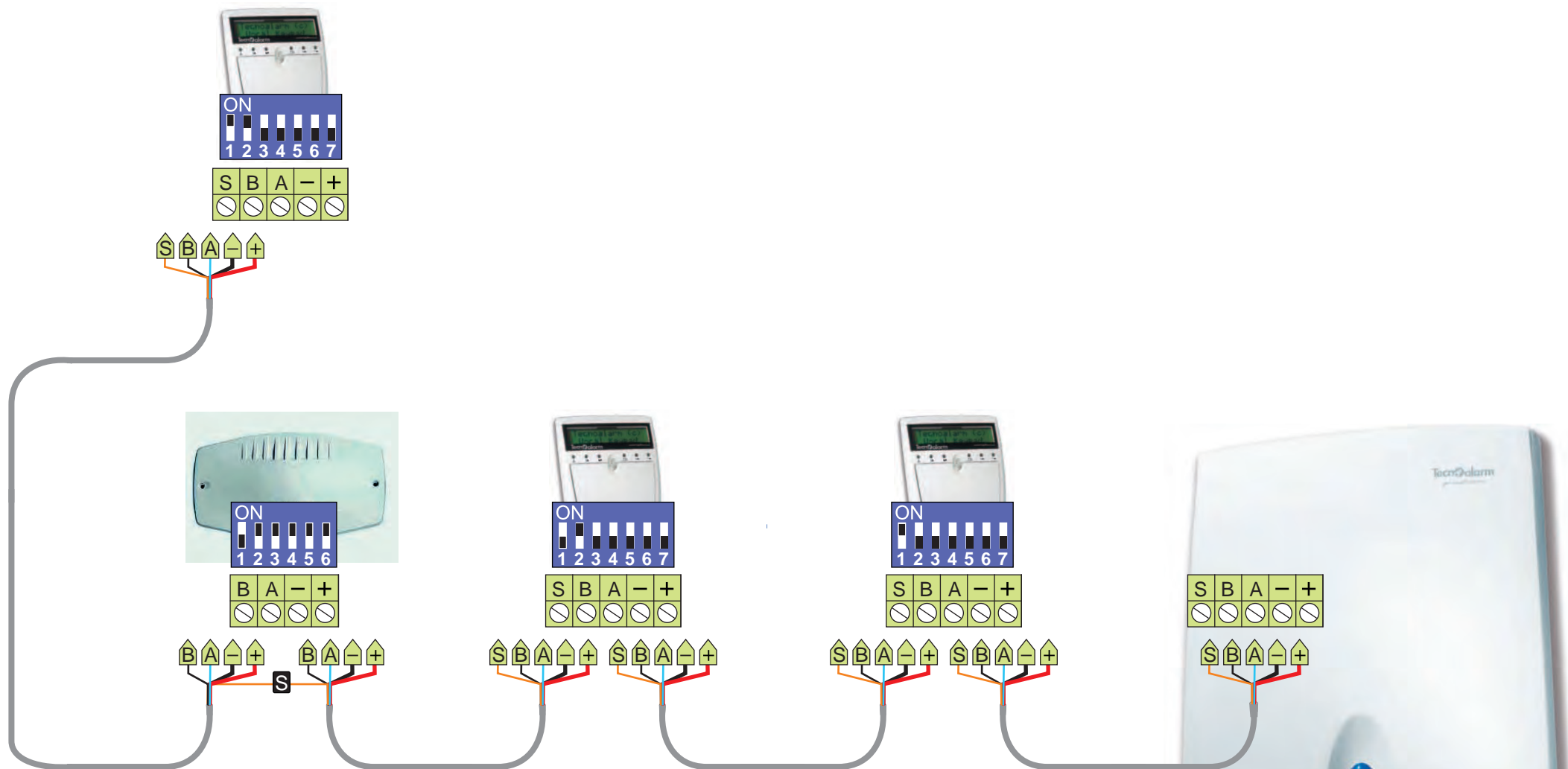

- Rosso Nero (2x1)
Alimentazione
 - Azzurro Nero Twistato
(2x0,50) segnali A e B
 - Giallo (1x0,50) segnale S
per Consolle e TecnoCell
- Cavo per Serial BUS RS485
Codice F1120000228

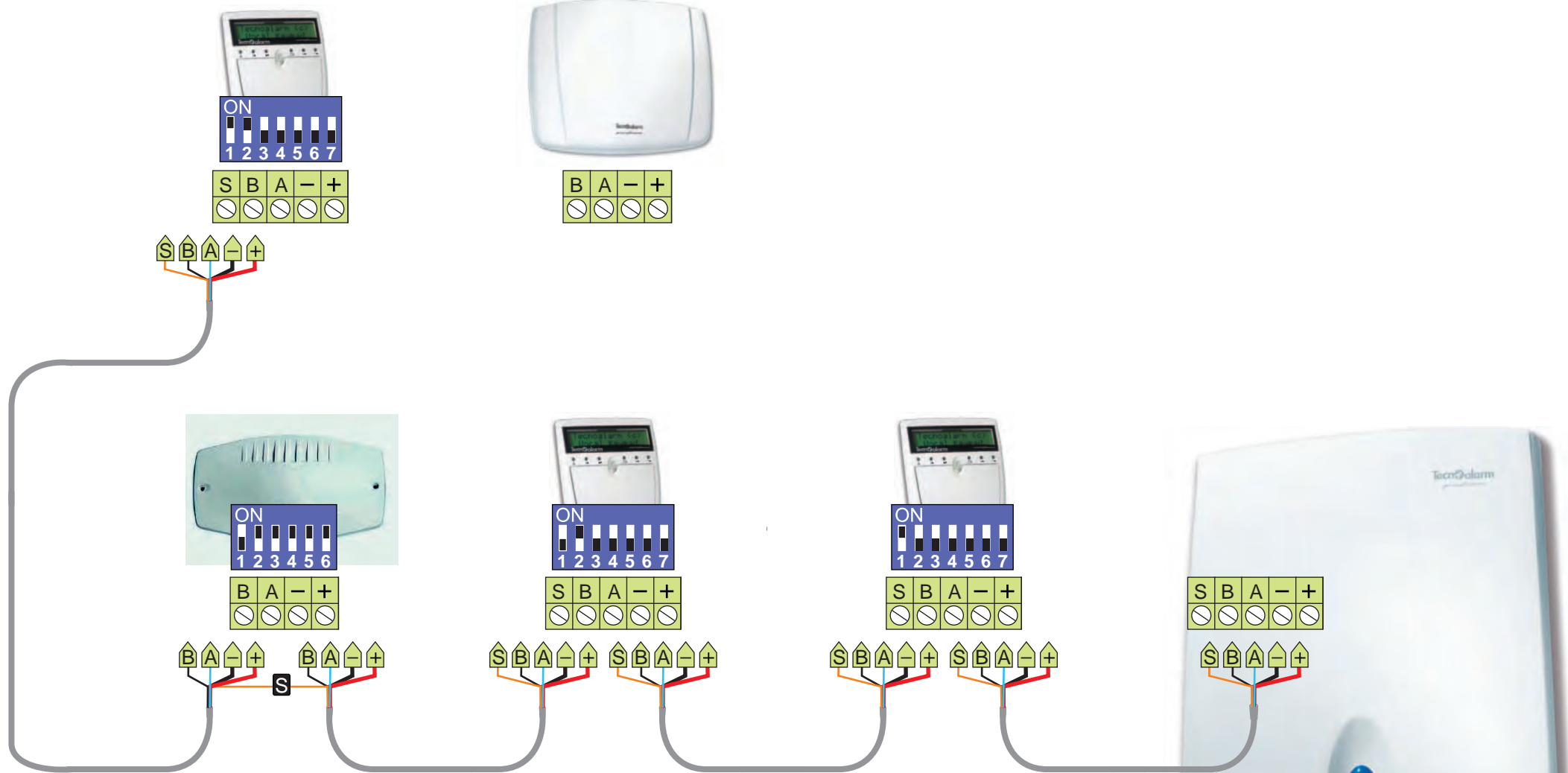

- Rosso Nero (2x1)
Alimentazione
 - Azzurro Nero Twistato
(2x0,50) segnali A e B
 - Giallo (1x0,50) segnale S
per Consolle e Tecnocell
- Cavo per Serial BUS RS485
Codice F1120000228

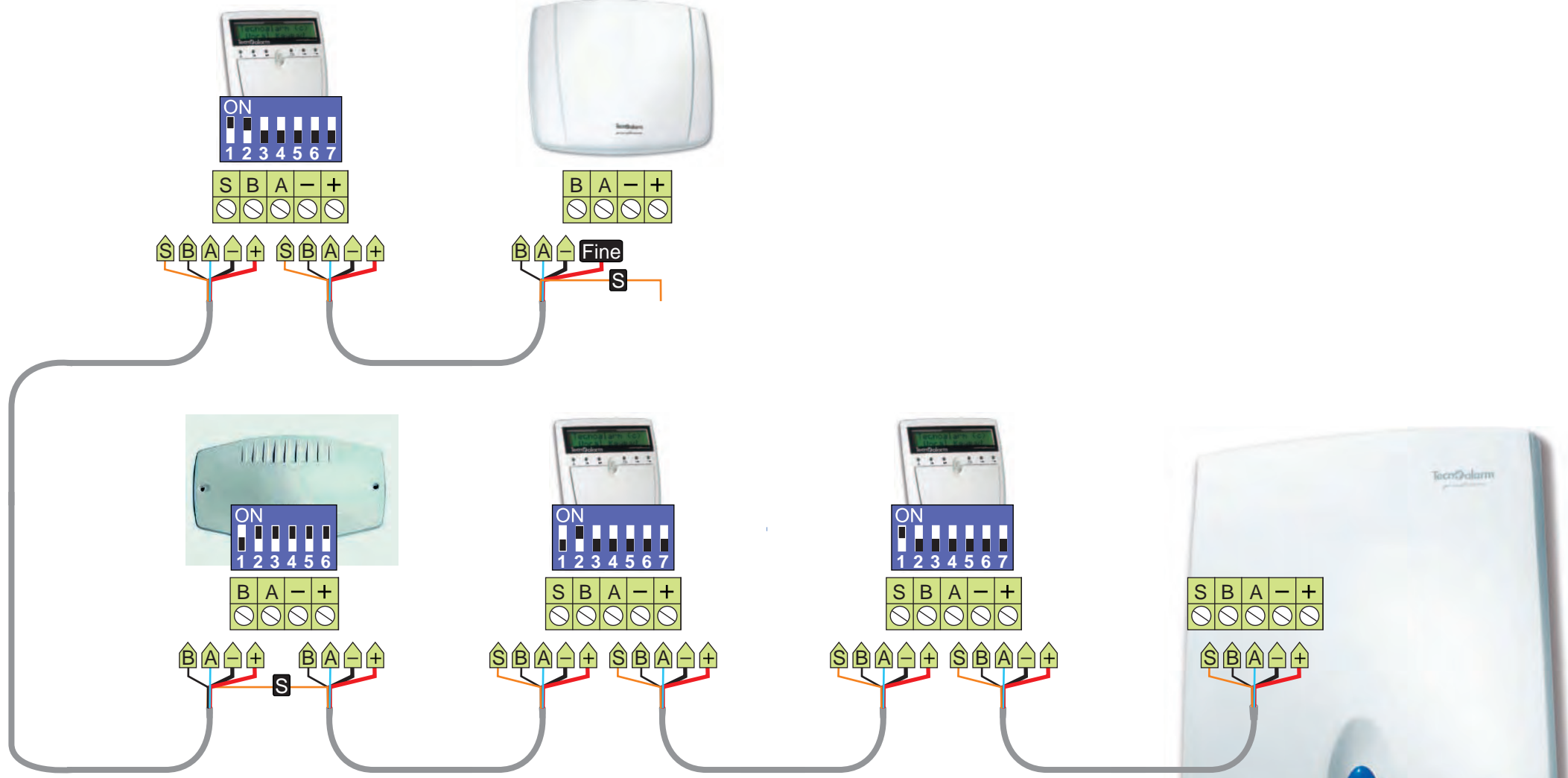

Rosso Nero (2x1)
 Alimentazione

Azzurro Nero Twistato
 (2x0,50) segnali A e B

Giallo (1x0,50) segnale S
 per Consolle e TecnoCell

Cavo per Serial BUS RS485
 Codice F1120000228

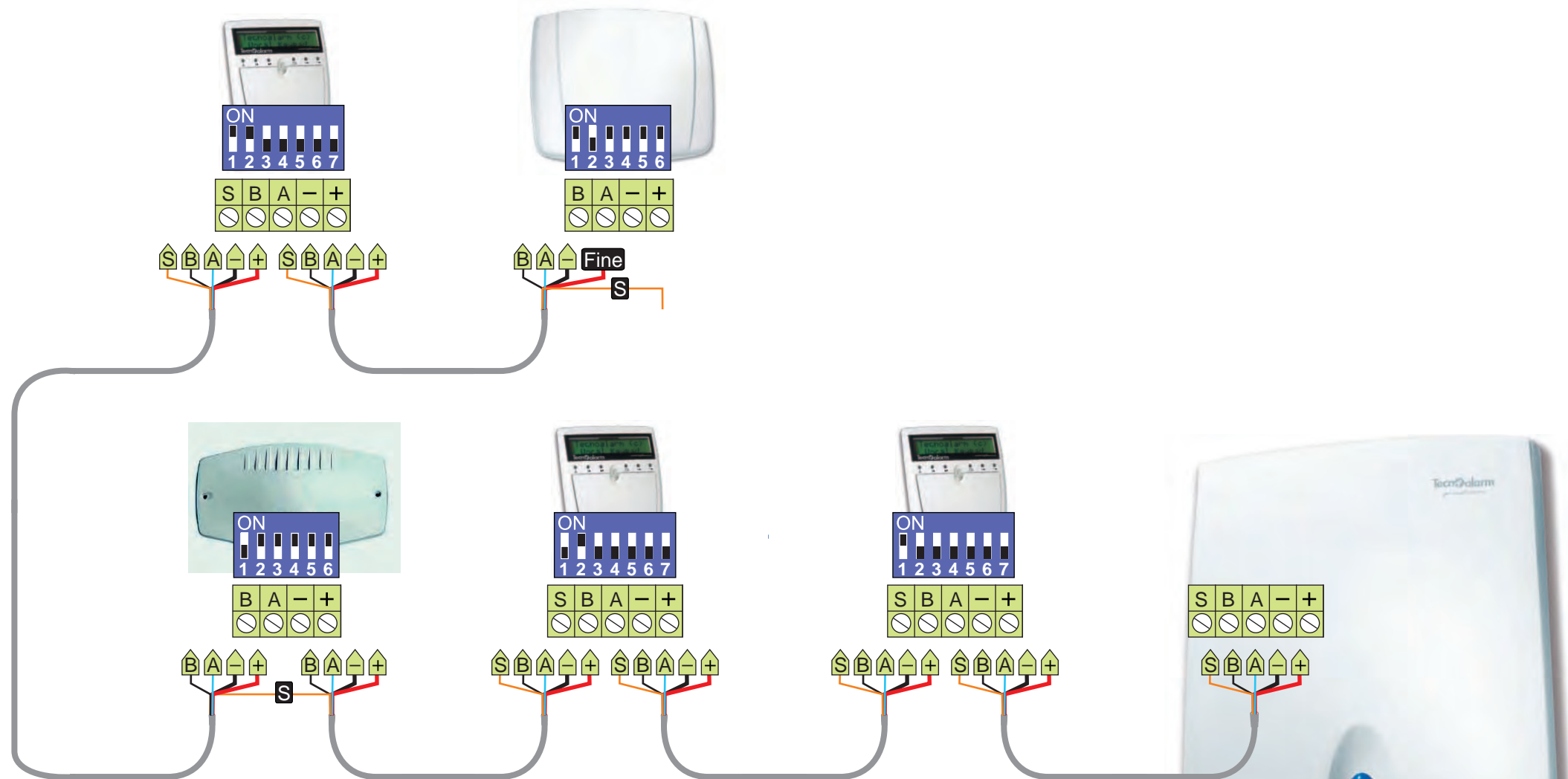

- Rosso Nero (2x1)
Alimentazione
 - Azzurro Nero Twistato
(2x0,50) segnali A e B
 - Giallo (1x0,50) segnale S
per Consolle e Tecnocell
- Cavo per Serial BUS RS485
Codice F11200000228

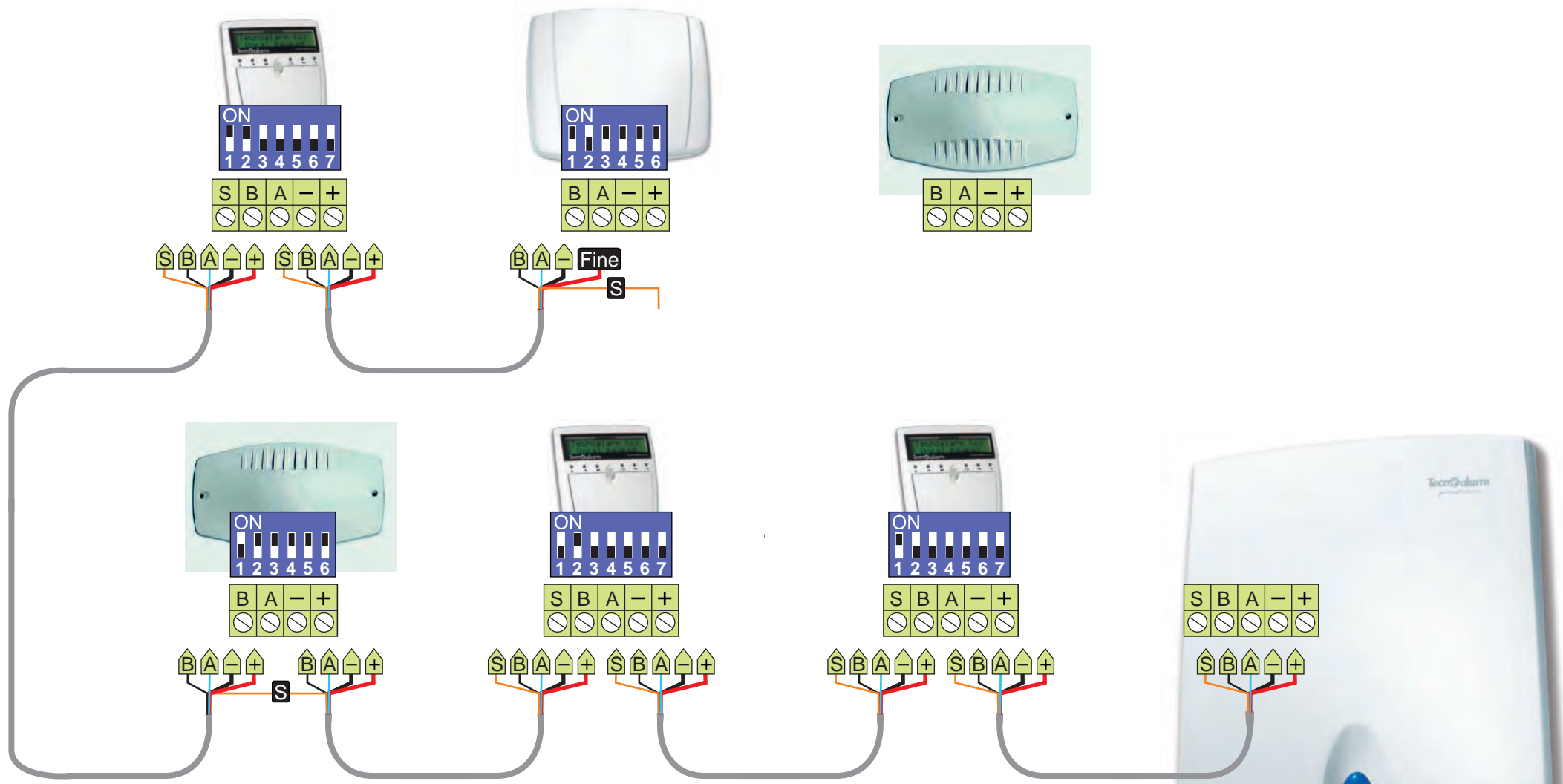

Rosso Nero (2x1)
 Alimentazione

Azzurro Nero Twistato
 (2x0,50) segnali A e B

Giallo (1x0,50) segnale S
 per Consolle e Tecnocell

Cavo per Serial BUS RS485
 Codice F11200000228

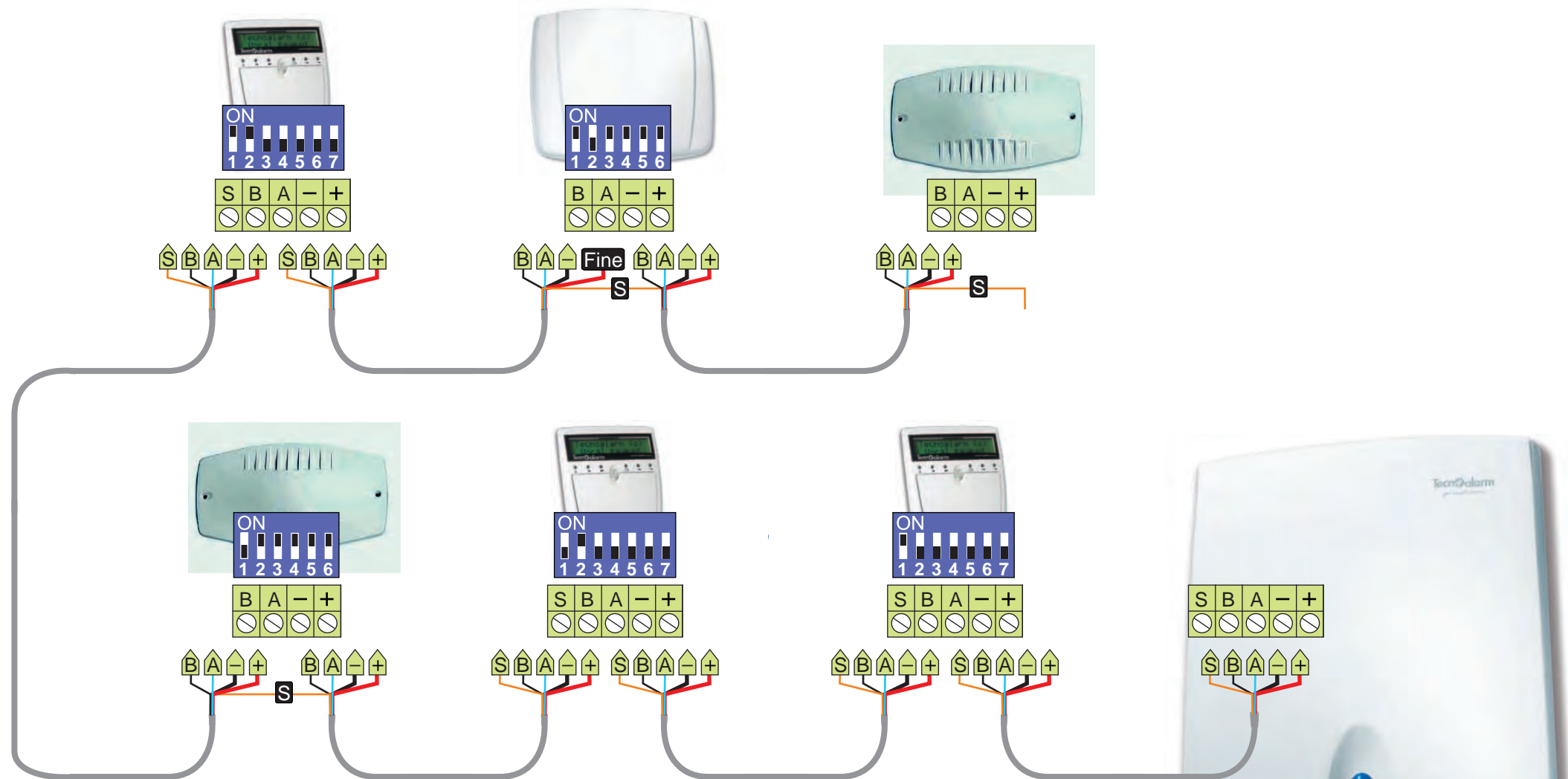

Rosso Nero (2x1)
 Alimentazione

Azzurro Nero Twistato
 (2x0,50) segnali A e B

Giallo (1x0,50) segnale S
 per Consolle e TecnoCell

Cavo per Serial BUS RS485
 Codice F11200000228

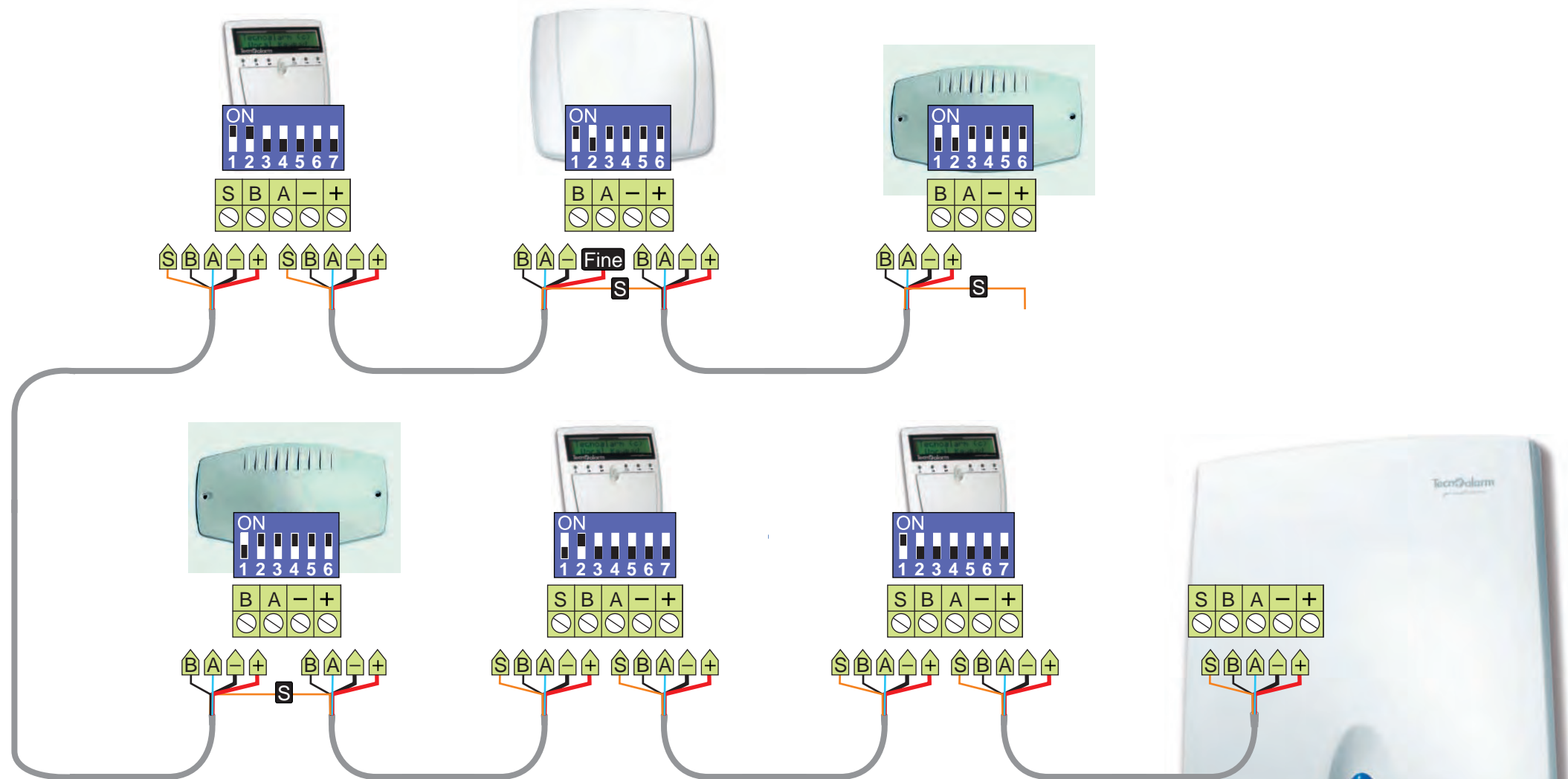

Rosso Nero (2x1)
 Alimentazione

Azzurro Nero Twistato
 (2x0,50) segnali A e B

Giallo (1x0,50) segnale S
 per Consolle e TecnoCell

Cavo per Serial BUS RS485
 Codice F1120000228

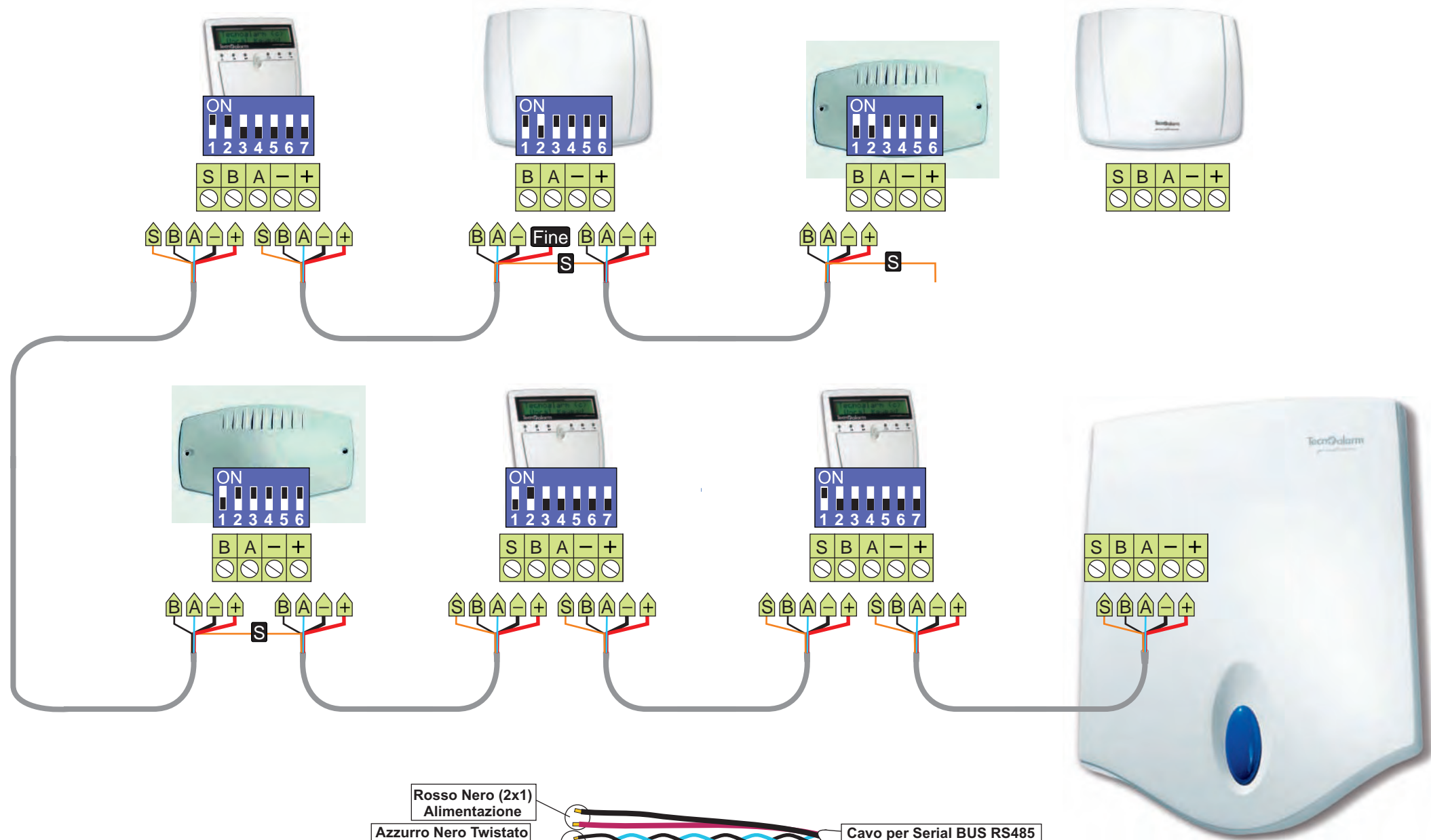

Rosso Nero (2x1)
 Alimentazione

Azzurro Nero Twistato
 (2x0,50) segnali A e B

Giallo (1x0,50) segnale S
 per Consolle e Tecnocell

Cavo per Serial BUS RS485
 Codice F1120000228

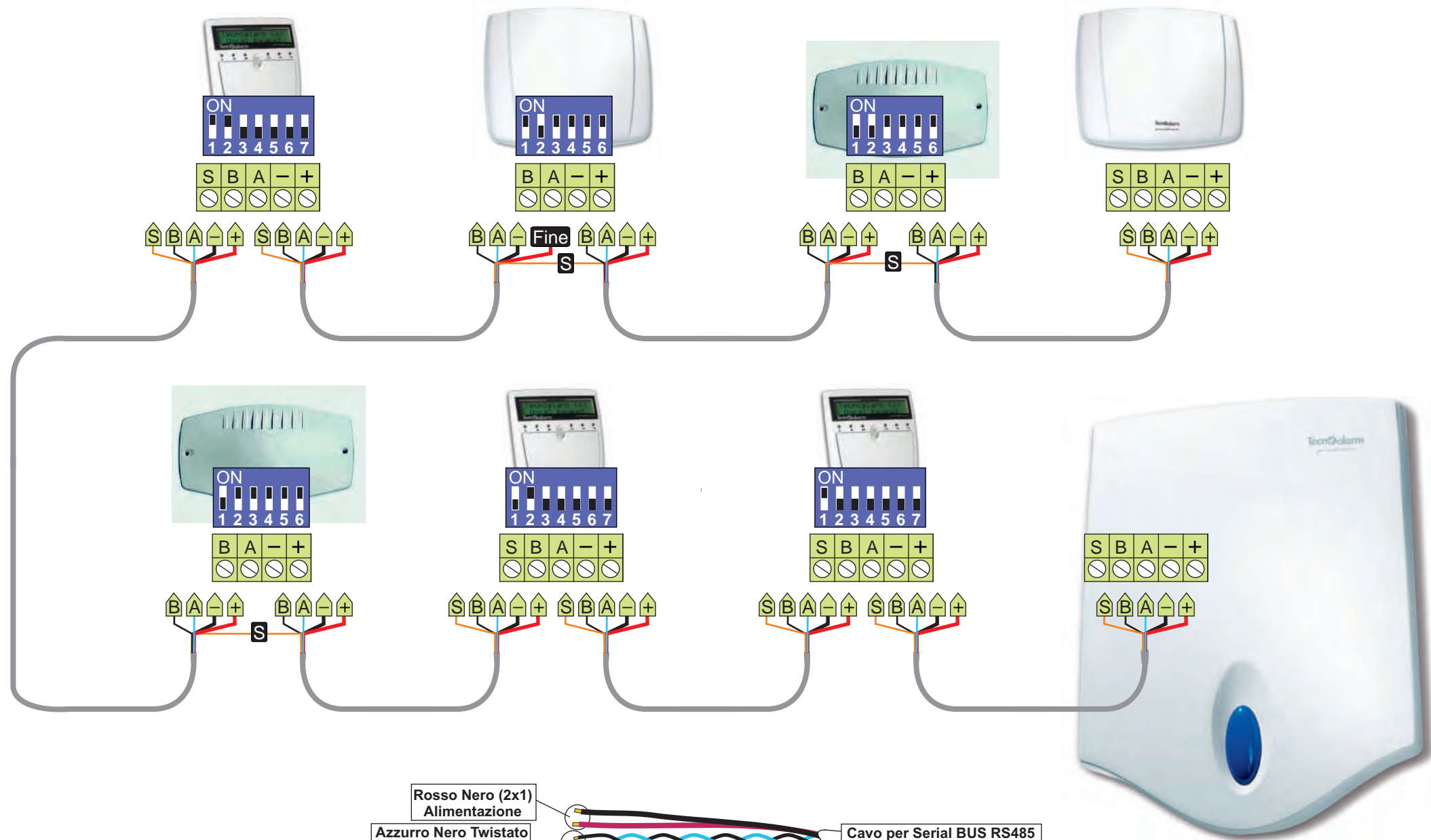

Rosso Nero (2x1)
 Alimentazione

Azzurro Nero Twistato
 (2x0,50) segnali A e B

Giallo (1x0,50) segnale S
 per Consolle e TecnoCell

Cavo per Serial BUS RS485
 Codice F11200000228